

TEKNION CORPORATION
 IN CANADA:
 1150 FLINT ROAD
 TORONTO, ONTARIO
 M3J 2J5 CANADA
 TEL 866.TEKNION
 866.835.6466
 FAX 416.661.4586

IN THE USA:
 350 FELLOWSHIP ROAD
 MT LAUREL, NEW JERSEY
 08054 USA
 TEL 877.TEKNION
 877.835.6466
 FAX 856.552.5088

OTHER OFFICES LOCATED IN:
 EUROPE
 SOUTH AND CENTRAL AMERICA
 MIDDLE EAST
 ASIA
 RUSSIA
 FOR REGIONAL CONTACT
 INFORMATION GO TO
 www.teknion.com

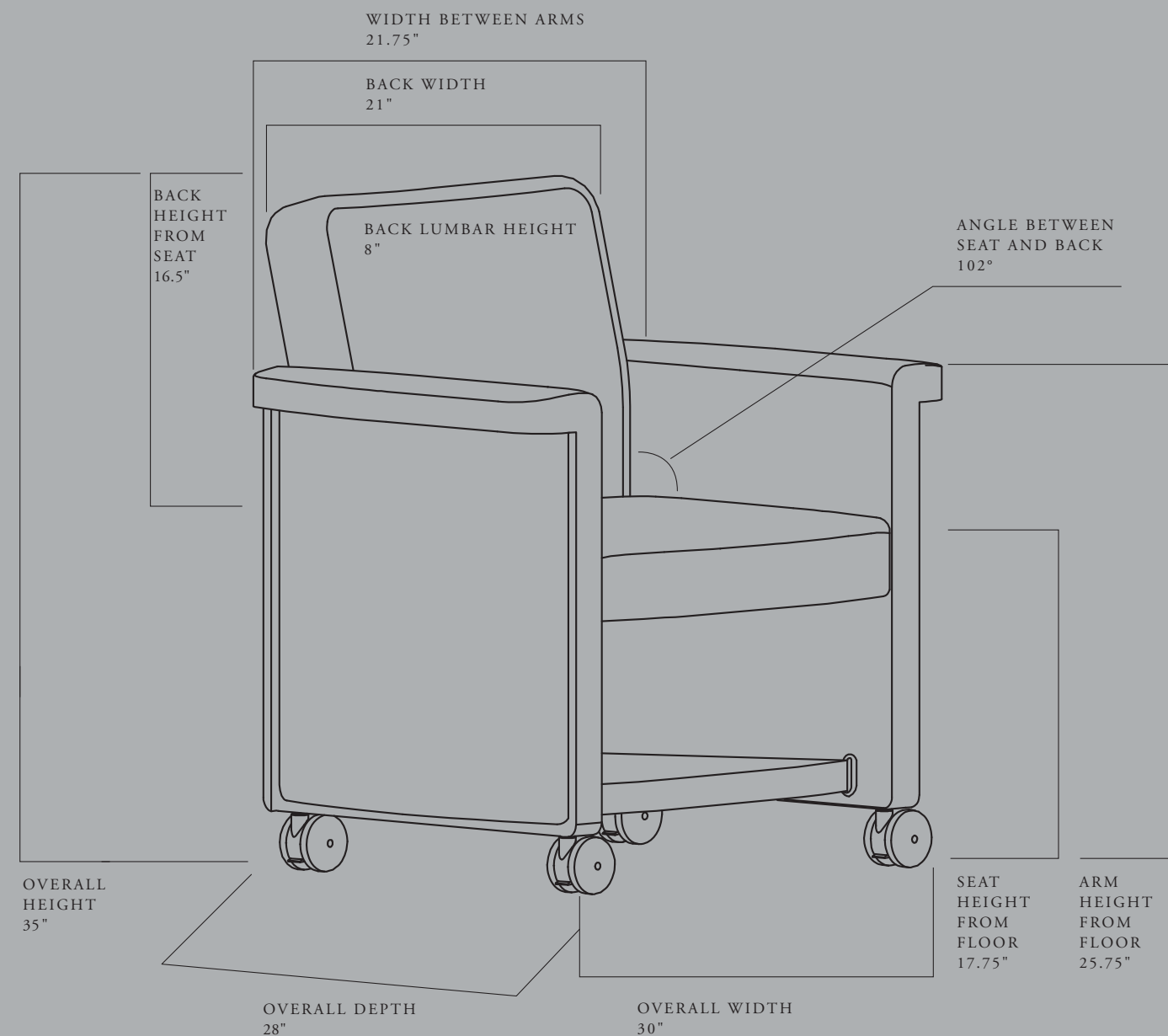

TEKNION EMBRACES CHANGE AND ITS INNATE POSSIBILITIES. OUR CULTURE IS ONE OF INNOVATION. IN THAT SPIRIT, WE HAVE STEPPED FORWARD TO INTEGRATE SUSTAINABLE PRINCIPLES AND PRACTICES INTO THE DESIGN, MANUFACTURING AND MARKETING OF OUR PRODUCTS.

TEKNION PRODUCTS PERFORM INDEPENDENTLY AND IN CONCERT, COMBINING IN VIRTUALLY UNLIMITED CONFIGURATIONS. OUR PHILOSOPHY EMBRACES DESIGN AS ONE OF THE BEST TOOLS WE HAVE FOR REALIZING THE BENEFITS OF BUSINESS, WHILE ALSO STRIVING TO REACH SUSTAINABLE GOALS.

WE HAVE LEARNED FROM DESIGN THAT CHANGING A SINGLE DETAIL ALTERS THE WHOLE. EVERY INCH MAKES A DIFFERENCE. EVERY LEAP IS THE SUM OF MANY SMALL STEPS.

TEKNION CREATES FURNITURE THAT CONNECTS PEOPLE, TECHNOLOGY AND SPACES; INTEGRATED DESIGN WITH NEW POSSIBILITIES FOR A HEALTHY, PRODUCTIVE WORLD TOMORROW AND THE DAY AFTER.



Belize

MOBILE, COMPACT

In both concept and function, Belize™ marks an innovative departure from conventional seating, offering versatility for a number of applications in the office or commercial settings. Scaled to make efficient use of space, Belize is equipped with a variety of features and options to enhance function and aesthetics.

FEATURES

- Storage shelf beneath the seat stores personal items
- Optional swivel work tablet with pen/pencil holder provides a working surface
- Cup holder with soft, non-slip surface accommodates various cup sizes
- In addition to casters, an unobtrusive handle in the chair back offers easy mobility

FINISHES

- Side panels are available in foundation laminate, perforated metal or upholstered in fabric or leather
- The work tablet is available with a foundation laminate or metal surface within a brushed aluminum frame

MIXED PLANNING

In today's office environment, work happens anywhere. Collaboration occurs spontaneously, requiring fluid spaces that allow people to meet and share information easily.

Versatile and adaptable, Belize is ideal for mixed plans that include collaborative settings and learning centers where work patterns and groups shift and evolve. Belize also meets the needs of quiet zones, spaces that offer privacy for individual work.

01.

Collaborative

Belize addresses the need for furniture that is mobile and flexible in collaborative meeting and teamwork areas. The chairs can be integrated into a panel-based environment for maximum functionality or grouped together in an open workspace to support impromptu interaction and collaboration.

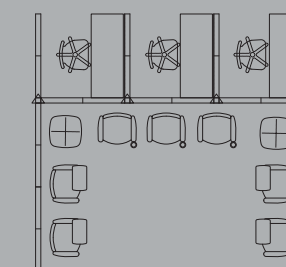

04.

Touchdown

The touch-down space is designed as a basic work area for short-term use. Belize enhances the functionality of the touch-down space with an additional worksurface, storage and convenient cup holder.

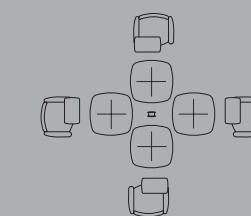

02.

Shared Learning

Belize is ideal for conferencing /training areas, providing a stable surface for writing, as well as convenient storage space for laptops and briefcases. The chair's mobility allows users to easily shift its position throughout the process of training or the progress of a meeting.

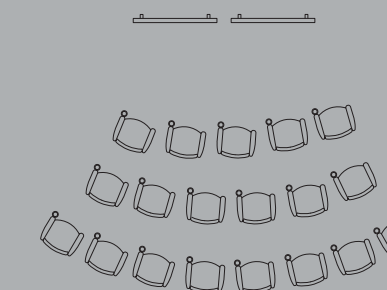

05.

Lounge / Reception

With today's portable electronic work tools, work can be conducted in almost any location, including reception areas and lobbies. Belize provides comfortable seating for guests in public areas, as well as a surface for writing or using a laptop to perform quick tasks.

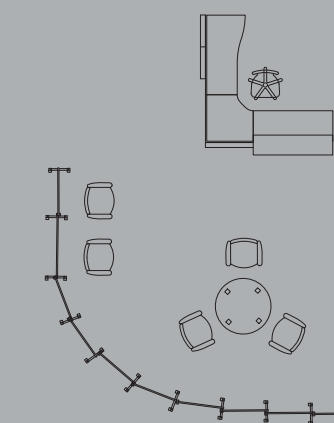

03.

Quiet Zone

In a library setting, Belize is appropriate for individual or group work. The chair's adjustable work tablet can be used for writing and taking notes while books and personal items can be stored within easy reach on the storage shelf under the chair.

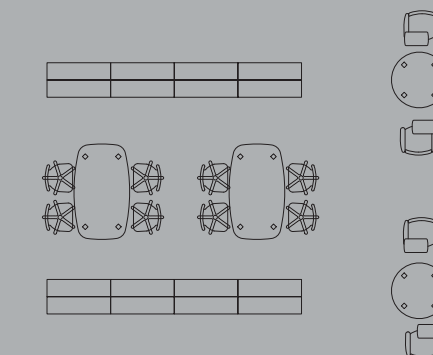

06.

Airport Lounge / Business Center

Designed to be mobile and functional, Belize supports a variety of different types of work in a lounge setting. Travelers can read, write and use portable work tools to maximize the productive use of time while traveling.

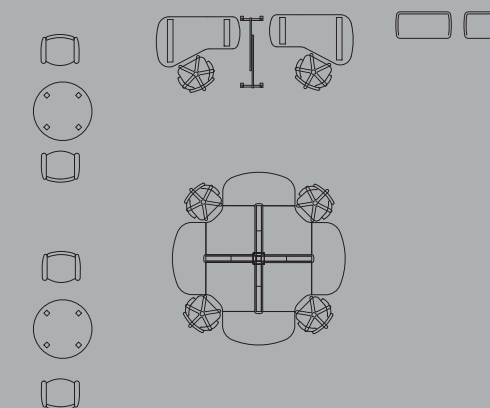

MODEL:
Perforated metal side panels; cup holder
UPHOLSTERY:
PolyBamboo, Water, White
SIDE PANELS:
Mica, Platinum



MODEL:
Foundation laminate side panels
UPHOLSTERY:
PolyBamboo, Water, White
SIDE PANELS:
Foundation Laminate, Bamboo Natural



MODEL:
Upholstered side panels; work tablet; cup holder
UPHOLSTERY:
PolyBamboo, Water, White
TABLET:
Mica, Platinum



MODEL:
Upholstered side panels; work tablet
UPHOLSTERY:
PolyBamboo, Water, White